

压敏电阻器

Zinc oxide varistors

- ☑ 电子电路过压保护型压敏电阻器
Electronic circuit overvoltage protection type varistors

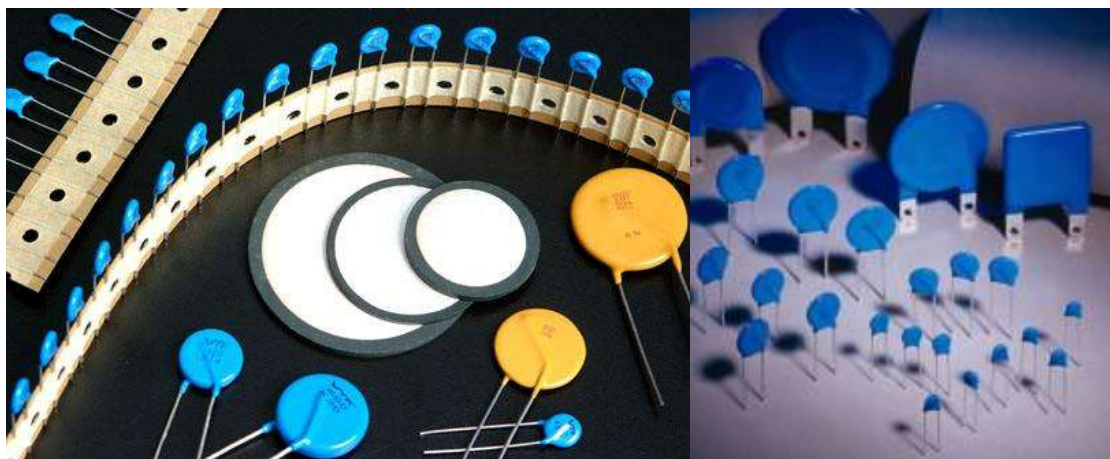

简介

Introductions

金属氧化物压敏电阻器简称为MOV或压敏电阻器；压敏电阻器是由variable（可变的）和resistor（电阻）两字合并而来，所以也称为可变电阻器。

Metal oxide varistor is referred to as MOV or varistor, the varistor is **variable** and **resistor** the word from the merger, it is also known as variable resistors.

如图1 所示，该组件具有双向并对称的V-I特性，拥有良好的浪涌吸收能力和非线性的电气特性。压敏电阻器以氧化锌为主体并添加多种金属氧化物，经过压合和烧结，如图2 所示，成为具有晶界特性的多晶半导体陶瓷组件，可产生非线性电流-电压特性。

As shown in Fig. 1, this component has a bi-directional and symmetrical V - I characteristic with good surge absorption capability and non-linear electrical characteristics. The varistor is made of zinc oxide as a main body and a variety of metal oxides are added. After pressing and sintering, as shown in Fig. 2, a polycrystalline semiconductor ceramic module having grain boundary properties can be used to generate nonlinear current-voltage characteristics.



图1.压敏电阻器的V-I特性
Fig.1 ZnO Varistor V-I characteristics



图2.电子显微镜下的压敏电阻器
Fig.2 ZnO Varistor SEM micrograph

压敏电阻器的主要用途就是保护设备免受瞬时过电压（浪涌）的破坏，当压敏电阻器遭受瞬时过电压时，压敏电阻器会从稳定状态（近似开路）转向限压状态（高导电状态）。压敏电阻器的典型V-I特性曲线如图所示。

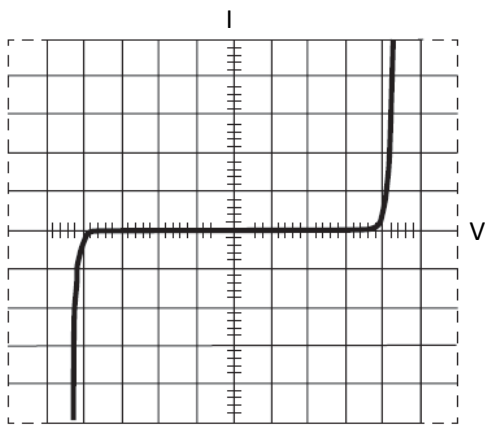
The main purpose of the varistor is to protect the device from transient overvoltage (surge) damage, When the varistor is subjected to transient overvoltages, the varistor will shift from a steady state (approximately open) to a regulated state (high conductivity). The typical V-I characteristic of the varistor is shown in Fig

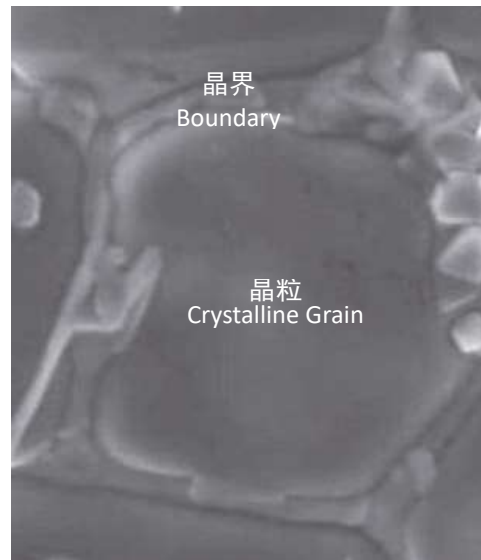

图3. 压敏电阻器典型V-I特性曲线
Fig. 3 Typical V-I characteristic curves of varistor

在漏电流区, 压敏电阻器的V-I 特性近似线性关系。此时压敏电阻器呈现高阻状态, 近似绝缘体, 可看作开路。
At leakage region, the V-I curve of varistor shows like a linear relationship. The varistor is in high resistance mode and shows as an open circuit.

在工作区, 压敏电阻器的V-I 曲线可以用下面的指数函数描述

In normal operation region, the V-I curve of a varistor can be described by power law:

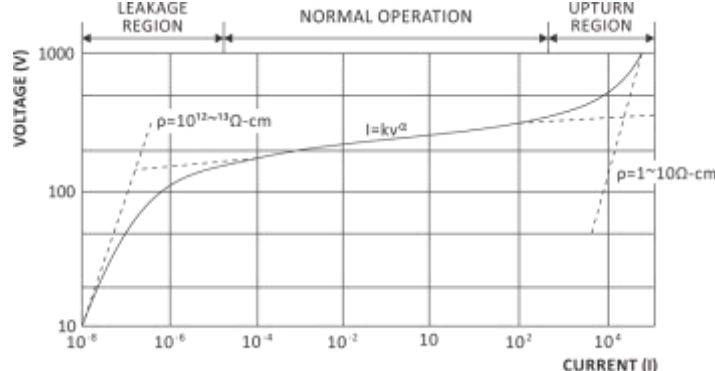
$$I=kV^\alpha$$

在这里, k为常数, α 表示非线性系数。

Where k is a constant and α defines the degree of nonlinearity.

在上升区, 压敏电阻器呈现低阻状态, 可以看作短路。

At upturn region, the varistor is in low resistance mode and shows as a short circuit.

压敏电阻器优于其它浪涌抑制器之处:

Advantages Compared with Other Transient Suppressors:

1) 更好的热特性

Better Thermal Properties

与硅二极管只有一个 P-N 结承受浪涌电流不一样, 压敏电阻器是由数百万个 P-N 结组成, 这种结构有更好的能量吸收能力和浪涌电流承受能力。

A silicon suppressor has only one P-N junction to handle the current, but varistor has millions of P-N junctions to offer better energy dissipation capability and peak current handling capability.

2) 反应速度快

Speed of Response

压敏电阻器有与其它的半导体组件类似的动作特性。因为压敏电阻器的传导发生非常快, 反应在纳秒级的范围内, 所以能够满足任何实际需求。

The action of varistor is similar to that of other semiconductor devices, and its conduction happens very fast (nanosecond range). In other words, varistor is fast enough to response to any practical requirements.

3) 过温条件下有稳定的限压

Stable Clamping Voltage over Temperature

在超过崩溃电压的情况下, 一旦环境温度超过正常的工作温度范围, 齐纳二极管的限制电压会随着环境温度的升高而升高, 而压敏电阻器的限制电压在超过工作温度范围的情况下仍然几乎保持恒定。当压敏电阻器的漏电流随着组件本体温度的升高而增加时, 压敏电阻器的限制电压不会随着温度变化而改变。

Beyond the breakdown point, the clamping voltage of varistor is almost constant over wide range of operating temperature while the clamping voltage of zener diode is higher at upper operation temperature. Even though leakage current of varistor increases following the rise of temperature, its clamping voltage is temperature independent.

4) 电容

Capacitance

与齐纳二极管相比, 压敏电阻器有更高的电容值。浪涌抑制器电容值的考虑因应用领域而有不同, 在直流电路中, 压敏电阻器的电容可起到去耦和抑制瞬时过电压的双重作用。

Compared with zener diodes, varistors have higher capacitance. Depending on the application, transient suppressor capacitance can be a desirable or undesirable feature. In DC circuits, the capacitance of varistors provides both decoupling and transient voltage clamping functions.

5) 低成本

Less Expensive

与二极管相比, 压敏电阻器具有成本低和尺寸小的优点。

Compared with diodes, varistor has small size and is cost-effective.

术语

Terms and definitions

1) 压敏电压

Varistor voltage

特定的电流(1mA DC)流经压敏电阻器时, 在压敏电阻器两端所测得的电压值。

The voltage across the varistor measured with the specified DC current 1mA.

2) 漏电流

Leakage current

漏电流是指压敏电阻击穿导通以前的电流, 即电压低于 U_{1mA} 时测量的电流。

The leakage current is the current before the varistor breakdown conduction, That is, when the voltage is lower than U_{1mA} measured current.

3) 最大连续工作电压

Maximum Continuous (or Operating) Voltage

也称之为最大允许电压, 是可连续加于压敏电阻器而不导致产生劣化情况的最大工作电压, 包括 VDC 和 VAC。

The maximum continuous or operating voltage (AC/DC) that can be applied continuously across the varistor, It's also known as the maximum allowable voltage.

4) 最大限制电压

Maximum Clamping Voltage

以特定脉冲电流(I_p , 8/20 μ s 波形)加在压敏电阻器上所得到的最大电压, 8/20 μ s 波形如下图所示。

The maximum voltage across the varistor with the specified standard impulse current (I_p , 8/20 μ s waveform) applied as shown below.

5) 最大能量

Maximum Energy

以特定脉冲电流(10/1000 μ s 波形)加在压敏电阻器上, 压敏电压的变化率小于 $\pm 10\%$ 的最大能量。

The maximum energy can be applied within the varistor voltage change of $\pm 10\%$ when a single impulse current of 10/1000 μ s.

6) 最大冲击(脉冲)电流

Maximum peak (or pulse) Current

也称之为耐冲击电流, 以特定脉冲电流(8/20 μ s 波形)冲击压敏电阻器一次或两次(每次间隔 5 分钟), 压敏电压的变化小于 $\pm 10\%$ 的最大冲击电流。

The maximum current within the varistor voltage change of $\pm 10\%$ with a single standard impulse current of 8/20 μ s is applied or two times with an interval of 5 minutes. It's also known as the withstanding surge current.

7) 额定功率

Rated Power

是指在 85°C 的特定环境温度下工作 1000 小时, 压敏电压的变化小于 10%的最大功率。

The power can be applied in the specified ambient temperature of 85°C, the change in varistor voltage is less than 10% of the maximum power.

8) 参考电容

Reference Capacitance

在特定频率(1KHz)和偏压(1Vrms)下所测得的电容值。

The capacitance of the varistor at a specified frequency (1kHz) and bias (1Vrms).

型号命名方式

Part Number

型号命名方式举例说明如下，当在订购具体规格时，请参考规格表与下列说明。

Way of product type naming illustrated as follows, Please refer to the specification chart and the following instructions when the order detailed specifications.

WZV **07** **D** **471** **K** **G** **S** **3** **20** **000**

① ② ③ ④ ⑤ ⑥ ⑦ ⑧ ⑨ ⑩

① 压敏电阻器型号

WZV: 电子电路过压保护型压敏电阻器 (引线式压敏电阻器)

Electronic circuit overvoltage protection type varistors (Lead varistors)

② 压敏电阻器陶瓷片的直径, 单位 mm, 如 07 表示 7mm, 14 表示 14mm
Ceramic chip diameter of varistor, unit is mm, e.g. 07 is 7mm, 14 is 14mm etc.

③ 陶瓷片形状, D 表示圆形, S 表示方形
Ceramic chip shape, D is disc, S is square.

④ 表示压敏电压, 单位 V, 如 471 为 470V, 180 为 18V 等
Varistor voltage, unit is Volt, e.g. 471 is 470V, 180 is 180V etc.

⑤ 压敏电压误差, K 表示±10%, L 表示±15%
Varistor voltage tolerance, e.g. K is ±10%, L is ±15% etc.

⑥ 能量等级, G 表示普通型, J 表示高能型,
Energy grade, G is general type, J is high energy type,

⑦ 引线形状 (脚型), 如 S 表示直脚, K 表示外弯脚, V 表示平行脚等
Lead style, e.g. S is straight lead, K is outside kink lead, V is vertical kink lead etc.

⑧ 引线间距 (脚距), 如 3 表示脚距 5mm, 5 表示脚距 7.5mm, 6 表示脚距 10mm 等
Lead spacing, e.g. 3 is 5mm, 5 is 7.5mm, 6 is 10mm etc.

⑨ 散件包装时, 表示脚长, 如 03 表示脚长 3mm, 08 表示脚长 8mm, 20 表示脚长 20mm, 3E 表示脚长 3.5mm 等;

Bulk packing, it is lead length, e.g. 03 is 3mm, 08 is 8mm, 20 is 20mm, 3E is 3.5mm etc.

编带包装时, 表示包装方式与元件间距离 (P), 如 T1 表示折叠包装与元件间距离 P 为 12.7mm, R2 表示卷盘包装与元件间距离 P 为 25.4mm 等。

Tape packing, it is package style and component pitch (P), eg T1 is ammo packing and P=12.7mm, R2 is reel packing and P=25.4mm etc.

⑩ 内部生产控制编码, 本规格书不作说明。

Internal control code, will not be described in this catalog

电子电路过压保护型压敏电阻器

Electronic circuit overvoltage protection type varistors

特点

- 小型紧凑，耐电涌电流量大
- 能响应瞬时浪涌的卓越灵敏度
- 限制电压低，保护效果可靠
- 无续流
- 已应对 RoHS 指令，无卤

用途

- 消费电子产品：电视机、音频输出设备、安全插座、机顶盒等
- 工业产品：马达、半导体元件、继电器、电磁开关、电源线路、三相整流线路、自动控制线路等
- 通信设备：电话机、传真机、交换机等
- 计算机：计算机、显示器、打印机、扫描仪、电源、电源适配器等
- 汽车电子产品

Features

- Very large surge withstanding capability with a compact size
- Fast response to steep impulse voltage
- Low clamping voltage for better surge protection
- No follow-on current
- RoHS compliant, halogen-free

Applications

- Consumer electronics products: television, audio output device, Safety plug, STB etc.
- Industrial products: motor, semiconductor component, relay, electromagnetic switch, power circuit, Three-phase rectifier circuit, automatic control circuit etc.
- Communication equipment: Telephone, facsimile, exchanger etc.
- Computer: computer, displayer, printer, scanner, power supply, adapter etc.
- Automotive electronics products



安规认证

Safety Approval

认证机构 Certificate Authority	认证标准 Approval standard	证书编号 Certificate No.	认证范围 Certification range		
			规格 Specs	压敏电压 Varistor voltage	最大连续交流电压 Maximum continuous operating voltage a.c.
CQC	GB/T 10193-1997 GB/T 10194-1997	CQC20001252105 CQC20001252153 CQC20001252151 CQC20001252149	07D	18V - 820V	11Vac - 510Vac
			10D	18V - 1100V	11Vac - 680Vac
			14D	18V - 1800V	11Vac - 1100Vac
			20D	18V - 1800V	11Vac - 1100Vac
VDE	DIN EN 61051-1:2009 IEC 61051-1:2007 IEC 61051-2:1991/AMDI:2009 IEC 61051-2:1991 IEC 61051-2-2:1991	40052040	07D	18V - 820V	11Vac - 510Vac
			10D	18V - 1100V	11Vac - 680Vac
			14D	18V - 1200V	11Vac - 750Vac
			20D	18V - 1200V	11Vac - 750Vac
UL	UL 1449	E490998	07D	18V - 820V	11Vac - 510Vac
			10D	18V - 1100V	11Vac - 680Vac
			14D	18V - 1800V	11Vac - 1100Vac
			20D	18V - 1800V	11Vac - 1100Vac

10D/14D/20D 通过了 6KV/3KA 组合波测试, 符合 IEC 60950-1 附录 Q 要求。

10D, 14D and 20D passed the 6KV/3KA combined wave test, in accordance with IEC 60950-1 Annex Q requirements.

一般特性

General Characteristics

压敏电压 (阈值电压) Varistor Voltage (threshold voltage)	18 V - 1 800 V	
工作电压范围 (最大允许电压) Working voltage (Max. Allowable voltage)	AC(rms)	11 Vac - 1000 Vac
	DC	14 Vdc - 1465 Vdc
最大脉冲电流(8/20μS) Peak Current for 8/20μS Current Wave	普通型 General type	100 A - 6 500 A
	高能型 Hi-energy type	250 A - 10 000 A
最大能量 (10/1 000μS) Energy Range For 10/1 000μS Current Wave	普通型 General type	0.4 J - 625 J
	高能型 Hi-energy type	0.6 J - 990 J
操作温度范围 Operation Ambient Temperature Range	-40°C ~ +125°C	
储存温度范围 Storage Temperature Range	-55°C ~ +125°C	
绝缘电阻 Insulation Resistance	> 1 000 MΩ	
包封层耐压 Hi-Pot (Leads to Coating)	2 500 VDC for 1 min.	
响应时间 Typical Response Time	< 25 ns	
电压-温度特性最大值 Maximum Voltage-Temperature Coefficient	< -0.05% / °C	

适用范围

Scope of applications

规格 Specs	规格 Specs	规格 Specs	规格 Specs	主要用途 Recommended Applications
07D180K 07D220K 07D270K 07D330K 07D390K 07D470K 07D560K 07D680K	10D180K 10D220K 10D270K 10D330K 10D390K 10D470K 10D560K 10D680K	14D180K 14D220K 14D270K 14D330K 14D390K 14D470K 14D560K 14D680K	20D180K 20D220K 20D270K 20D330K 20D390K 20D470K 20D560K 20D680K	用于低压电路，如用于保护半导体器件、汽车电子产品、DC48V 以下的继电器与电磁阀、静电放电设备、行动电话等 For the low voltage circuit, Such as for the protection of semiconductor devices, automotive electronics, DC48V following relays and solenoid valves, electrostatic discharge equipment, mobile phones, etc.
07D820K 07D101K 07D121K 07D151K	10D820K 10D101K 10D121K 10D151K	14D820K 14D101K 14D121K 14D151K	20D820K 20D101K 20D121K 20D151K	用于电话，直流 48V 通信电路电线 Telephone, Communication Line (DC 48 V)
07D181K 07D201K 07D221K	10D181K 10D201K 10D221K	14D181K 14D201K 14D221K	20D181K 20D201K 20D221K	用于交流 100V 线与线间（如日本） AC 100 V Line-Line Applications (Japan etc.)
07D241K 07D271K 07D301K	10D241K 10D271K 10D301K	14D241K 14D271K 14D301K	20D241K 20D271K 20D301K	用于交流 100~120V 线与线间（如日本、美国、加拿大等） AC 100 V to 120 V, Line-Line Applications (Japan, US, Canada etc.)
07D331K 07D361K 07D391K	10D331K 10D361K 10D391K	14D331K 14D361K 14D391K	20D331K 20D361K 20D391K	用于交流 100~120V 线与线间 用于电话（应对 250V 绝缘阻抗测试） AC 100 V to 120 V, Line-Line Applications Telephone Line Applications (For DC 250 V Insulation Resistance Test)
07D431K 07D471K	10D431K 10D471K	14D431K 14D471K	20D431K 20D471K	用于交流 200~220V 线与线间、线与大地间 AC 200 V to 220 V, Line-Line and Line-Ground Applications
07D561K 07D621K 07D681K	10D561K 10D621K 10D681K	14D561K 14D621K 14D681K	20D561K 20D621K 20D681K	用于交流 240V 线与线间、线与大地间（如英国、澳洲、中东等） AC 240 V, Line-Line and Line-Ground Applications (UK, Australia, Middle east etc.)
	10D751K 10D781K 10D821K	14D751K 14D781K 14D821K	20D751K 20D781K 20D821K	用于交流 380V 线与线间、线与大地间 AC 380 V, Line-Line and Line-Ground Applications
	10D911K	14D911K	20D911K	用于交流 415V 线与线间、线与大地间 AC 415 V, Line-Line and Line-Ground Applications
	10D102K 10D112K	14D102K 14D112K	20D102K 20D112K	用于交流 480V 线与线间、线与大地间 AC 480 V, Line-Line and Line-Ground Applications
		14D182K	20D182K	用于线与大地间（应对 1200V 耐压测试） Line-Ground Applications (For AC 1200 V Withstanding Test)

标志

Marking

WZV 型压敏电阻器标志在本体上用激光雕刻而成，其内容如下图所示。

As shown in figure, the marking of WZV type varistor is laser engraving on the body.



压敏电阻器特性和额定值

Ratings and Characteristics of varistor

20D 系列

20D series

规格 Specs	压敏电压 Varistor Voltage (V1.0mA)	最大允许电压 Max. Allowable Voltage		最大限制电压 Max. Clamping Voltage		最大峰值电流 Max. Peak Current (8/20us)		最大能量 Maximum Energy (10/1000us)		额定 功率 Rated Power	最大 电容量 Capacitance (max.)
		ACrms	DC	Vc	Ip	通用 General	高能 Hi-energy	通用 General	高能 Hi-energy		
	Volts	Volts	Volts	Volts	Amps	Amps	Amps	Joules	Joules	Watts	pF @1kHz
20D180K	16.2-19.8	11	14	36	20	2000	3000	11	13	0.20	28500
20D220K	19.8-24.2	14	18	43				14	16		18500
20D270K	24.3-29.7	17	22	53				16	19		13000
20D330K	29.7-36.3	20	26	65				23	24		11500
20D390K	35.1-42.9	25	31	77				26	28		8500
20D470K	42.3-51.7	30	38	93				30	34		7400
20D560K	50.4-61.6	35	45	110				38	44		6500
20D680K	61.2-74.8	40	56	135		41	49	5800			
20D820K	73.8-90.2	50	65	135		45	56	4900			
20D101K	90-110	60	85	165		50	70	4000			
20D121K	108-132	75	100	200		55	85	3300			
20D151K	135-165	95	125	250		70	106	2700			
20D181K	162-198	115	150	300		85	130	2200			
20D201K	180-220	130	170	340		95	140	2000			
20D221K	198-242	140	180	360	100	155	1800				
20D241K	216-264	150	200	395	108	168	1650				
20D271K	243-297	175	225	455	127	190	1500				
20D301K	270-330	190	250	505	136	210	1300				
20D331K	297-363	210	275	545	150	228	1200				
20D361K	324-396	230	300	595	163	255	1100				
20D391K	351-429	250	320	650	180	275	1000				
20D431K	387-473	275	350	710	190	305	930				
20D471K	423-517	300	385	775	204	350	850				
20D511K	459-561	320	415	845	210	360	780				
20D561K	504-616	350	460	930	215	380	710				
20D621K	558-682	385	505	1020	224	390	650				
20D681K	612-748	420	560	1120	230	400	600				
20D751K	675-825	460	615	1240	255	420	530				
20D781K	702-858	485	640	1290	265	440	510				
20D821K	738-902	510	670	1355	282	460	500				
20D911K	819-1001	550	745	1500	310	510	440				
20D102K	900-1100	625	825	1650	342	565	400				
20D112K	990-1210	680	895	1815	383	620	360				
20D122K	1080-1320	750	990	1980	408	660	350				
20D142K	1260-1540	880	1140	2310	480	500	280				
20D152K	1350-1650	900	1200	2475	520	550	270				
20D162K	1440-1760	1000	1280	2640	550	580	250				
20D182K	1620-1980	1100	1465	2970	625	990	320				

尺寸规格

Dimension specifications

标准品尺寸规格

Dimensions of component for standard product

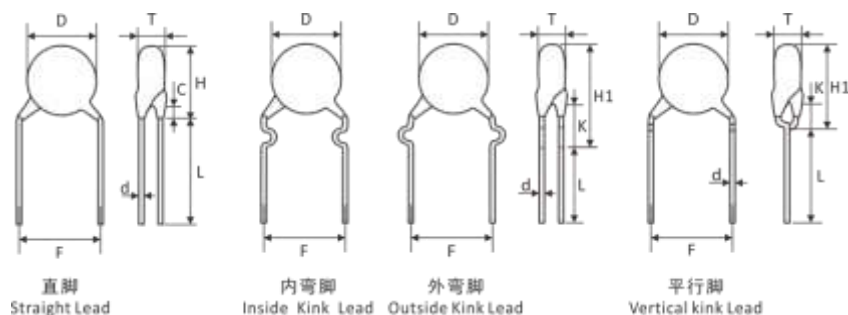

Specs 规格	D mm, max	F mm, ±1.0	L mm, min	D mm, ±0.1	C mm, max	K mm, max	H mm, max	H1 mm, max
20D	23.0	10.0	20	1.0	3.0	5.0	26.5	29.5

脚长 (L) 可以根据客户的要求进行定制, 本表上述规格通用要求。

Lead length (L) can be customized according to customer requirements, the table of the general requirements of the above specifications

■ T 尺寸标准表(mm, 最大值)

T dimension specification list (mm, maximum)

压敏电压	20D	压敏电压	20D
180	4.6	361	6.5
220	4.7	391	6.6
270	4.7	431	6.8
330	4.8	471	6.9
390	5.0	511	7.1
470	5.2	561	7.3
560	5.4	621	7.3
680	5.6	681	7.5
820	5.6	751	7.7
101	5.8	781	7.8
121	5.9	821	8.6
151	6.2	911	9.3
181	6.4	102	9.6
201	6.3	112	9.8
221	6.0	122	10.2
241	6.1	142	11.8
271	6.2	152	11.8
301	6.2	162	11.8
331	6.3	182	11.8

编带规格

Taping specifications



图 1 (适用于 07D/10D)
Fig 1 (apply to 07D/10D)



图 2 (适用于 10D/14D/20D)
Fig 2 (apply to 10D, 14D and 20D)

代码 Code	尺寸规格 Dimensions specifications (mm)						
	07D	10D			14	20	
F	5.0±0.8	7.5±0.8	7.5±0.8	7.5±0.8	7.5±0.8	7.5±0.8	10±0.8
d	0.60±0.1	0.80±0.1	0.80±0.1	0.80±0.1	0.80±0.1	0.80±0.1	1.00±0.1
P	12.7±1.0	12.7±1.0	25.4±1.0	15.0±1.0	25.4±1.0	30.0±1.0	25.4±1.0
P0	12.7±0.3	12.7±0.3	12.7±0.3	15.0±0.3	12.7±0.3	15.0±0.3	12.7±0.3
P1	3.85±0.7	1.6±0.7	8.95±0.7	3.75±0.7	8.95±0.7	3.75±0.7	8.95±0.7
P2	6.35±0.7	6.35±0.7	12.7±0.7	7.5±0.7	12.7±0.7	7.5±0.7	12.7±0.7
Δh	<2.0	<2.0	<2.0	<2.0	<2.0	<2.0	<4.0
ΔS	<1.3	<1.3	<1.3	<1.3	<1.3	<1.3	<1.3
t1	≤0.9	≤0.9	≤0.9	≤0.9	≤0.9	≤0.9	≤0.9
t2	≤1.5	≤1.7	≤1.7	≤1.7	≤1.7	≤1.7	≤1.9
W	18.0±0.5	18.0±0.5	18.0±0.5	18.0±0.5	18.0±0.5	18.0±0.5	18.0±0.5
W0	>7.0	>7.0	>7.0	>7.0	>7.0	>7.0	>7.0
W1	9.0±0.5	9.0±0.5	9.0±0.5	9.0±0.5	9.0±0.5	9.0±0.5	9.0±0.5
W2	<2.0	<2.0	<2.0	<2.0	<2.0	<2.0	<2.0
H	18.0+2/-0	18.0+2/-0	18.0+2/-0	18.0+2/-0	18.0+2/-0	18.0+2/-0	18.0+2/-0
H0	16.0±0.5	16.0±0.5	16.0±0.5	16.0±0.5	16.0±0.5	16.0±0.5	16.0±0.5
H1	<32.0	<36.0	<36.0	<36.0	<40.0	<40.0	<40.0
D0	4.0±0.2	4.0±0.2	4.0±0.2	4.0±0.2	4.0±0.2	4.0±0.2	4.0±0.2
L	<11.0	<11.0	<11.0	<11.0	<11.0	<11.0	<11.0
C	≤3.0	≤3.0	≤3.0	≤3.0	≤3.0	≤3.0	≤3.0
K	≤5.0	≤5.0	≤5.0	≤5.0	≤5.0	≤5.0	≤5.0

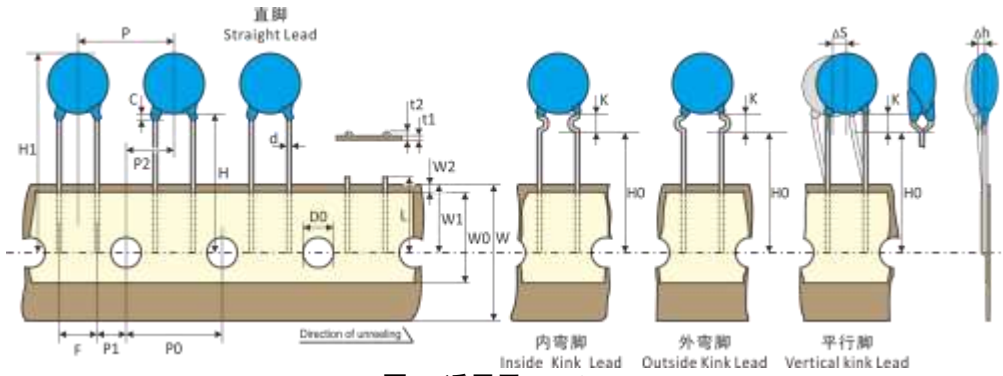
包装规格

Packing specifications

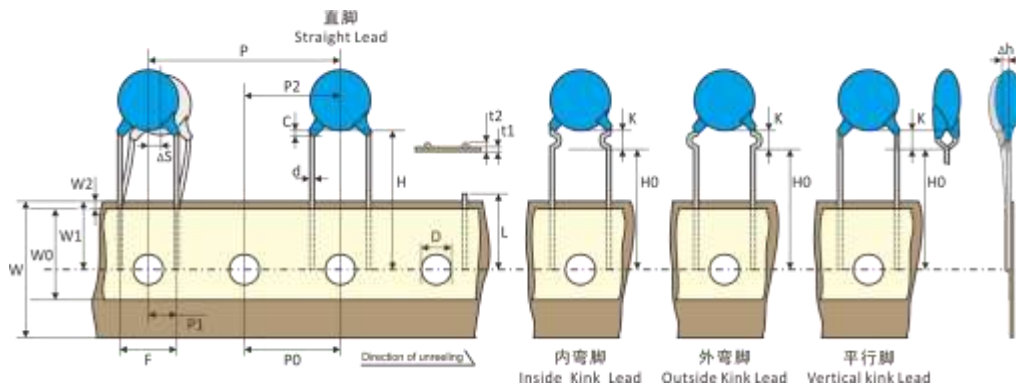
■ 散件包装

Bulk packing

规格 Specs	07D	10D	14D	20D
最小包装数量 Minimum Packaging Quantity	1 000 pcs	500 pcs	500 pcs	200 pcs

■ 编带包装

Taping packing

规格 Specs	压敏电阻 Varistor Voltage	卷盘包装(每卷) Reel Packing (per Reel)	折叠包装(每盒) Ammo Packing (per Box)
07D	< 471	1 500 pcs	1 500 pcs
	≥ 471	1 000 pcs	1 000 pcs
10D	< 471	1 000 pcs	1 000 pcs
	≥ 471	750 pcs	750 pcs
14D	< 471	1 000 pcs	1 000 pcs
	≥ 471	750 pcs	750 pcs
20D	< 471	500 pcs	500 pcs
	≥ 471	250 pcs	250 pcs

注：折叠包装和卷盘包装数量可能会改变。

Note: Quantity of Ammo packing and reel packing may change.

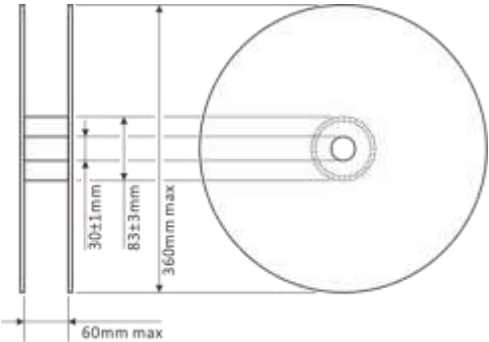
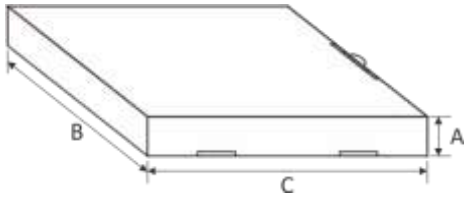
卷盘包装尺寸图 Dimensional drawing for reel packing	折叠包装尺寸图 Dimensional drawing for ammo packing		
			
	A	B	C
07D / 10D	43±2mm	256±5mm	333±5mm
14D / 20D	48±2mm	288±5mm	333±5mm

性能参数

Performance characteristics

电气参数

Electrical parameters

电气测量应在5至35℃，相对湿度最大值85%的条件下进行。

Electrical measurements shall be conducted at temperature of 5 to 35 °C, relative humidity of maximum 85 %.

特性 Characteristics	试验方法/说明 Test Methods/Description		标准 Specifications
压敏电阻 Varistor Voltage	额定 DC 电流 C_{mA} 流经压敏电阻器时，压敏电阻器两端的端子间电压标记为 V_C 或 V_{CmA} ，称为压敏电压。测定时应快速进行，以避免元件发热影响。 The voltage between two terminals with the specified measuring current C_{mA} DC applied is called V_C or V_{CmA} . The measurement shall be made as fast as possible to avoid heat affection.		满足额定值 To meet the specified value.
最大允许电压 Maximum Allowable Voltage	能连续施加的标准正弦波电压有效值的最大值或直流电压最大值 The maximum sinusoidal RMS voltage or maximum DC voltage that can be applied continuously.		满足额定值 To meet the specified value.
限制电压 Clamping Voltage	额定标准 8/20 μs 的脉冲电流流经压敏电阻器时端子间电压的最高值。 The maximum voltage between two terminals with the specified standard impulse current (8/20 μs) illustrated below applied.		满足额定值 To meet the specified value.
额定功率 Rated Power	能在指定的环境温度下使用的功率 The power that can be applied in the specified ambient temperature.		满足额定值 To meet the specified value.
最大能量 Maximum Energy	施加一次 10/1 000 μs 脉冲波或 2 ms 矩形波时，压敏电压的变化率在 $\pm 10\%$ 以内的最大能量。 The maximum energy within the varistor voltage change of $\pm 10\%$ when a single impulse current of 2 ms or 10/1 000 μs is applied.		满足额定值 To meet the specified value.
最大峰值电流 Maximum Peak Current	2 times	将 8/20 μs 标准波形脉冲电流间隔 5 分钟，分两次接入压敏电阻器时，压敏电压变化率在 $\pm 10\%$ 以内的最大电流值。 The maximum current within the varistor voltage change of $\pm 10\%$ when a standard impulse current of 8/20 μs is applied two times with an interval of 5 minutes.	满足额定值 To meet the specified value.
	1 time	将 8/20 μs 标准波形脉冲电流一次接入压敏电阻器时，压敏电压变化率在 $\pm 10\%$ 以内的最大电流值。 The maximum current within the varistor voltage change of $\pm 10\%$ with a single standard impulse current of 8/20 μs is applied.	
压敏电压温度系数 Temperature Coefficient of Varistor Voltage	$\frac{V_{CmA} \text{ at } 85^\circ\text{C} - V_{CmA} \text{ at } 25^\circ\text{C}}{V_{CmA} \text{ at } 25^\circ\text{C}} \times \frac{1}{60} \times 100 (\%/^\circ\text{C})$		0 ~ -0.05 %/°C
电容量 Capacitance	在环境温度为 25 $\pm 2^\circ\text{C}$ 、测定频率 1 kHz $\pm 10\%$ 、1Vrms 以下(低于 100pF 时为 1MHz)、压敏电压 0V 时测量。 Capacitance shall be measured at 1 kHz $\pm 10\%$, 1 Vrms max. (1 MHz $\pm 10\%$ below 100 pF), 0 V bias and 25 $\pm 2^\circ\text{C}$.		满足额定值 To meet the specified value
耐电压 (本体绝缘) Withstanding Voltage (Body Insulation)	在导线与紧密缠绕金属箔的本体间，施加规定的电压 1 分钟。 The specified voltage shall be applied between both terminals of the specimen connected together and metal foil closely wrapped round its body for 1 minute.		无击穿或飞弧 No breakdown
	类别 (标称压敏电压) Classification (Nominal varistor voltage)	$\leq 330 \text{ V}$ $> 330 \text{ V}$	
	试验电压 (AC) Test Voltage (AC)	1 000 Vrms 1 500 Vrms	

机械特性

Mechanical behavior

特性 Characteristics	试验方法 Test Methods		标准 Specifications
导线抗张强度 Terminal Tensile Strength	将主体固定，在端子上逐步施加额定的张力并保持约 10 秒钟，通过目测观察外观有无异状。 After gradually applying the force specified below and keeping the unit fixed for 10 seconds, the terminal shall be visually examined for any damage.		无明显机械性损伤 No remarkable mechanical damage
	引线直径 Terminal diameter	$\leq 0.8\text{mm}$ $> 0.8\text{mm}$	
	拉力 Force	9.8N 19.6N	

特性 Characteristics	试验方法 Test Methods	标准 Specifications						
导线抗折强度 Terminal Bending Strength	<p>使端子方向垂直，在端子的轴方向上施加额定的张力，直至主体呈 90 度弯曲。然后将其恢复原状，再向相反方向弯曲 90 度，之后恢复原状，又再向最初的方向弯曲 90 度后恢复原状。反复进行如上操作，通过目测观察外观有无异常。</p> <p>The unit shall be secured with its terminal kept vertical and the force specified below shall be applied in the axial direction. The terminal shall gradually be bent by 90° in one direction, then 90° in the opposite direction, and again back to the original position. The damage of the terminal shall be visually examined.</p> <table border="1"> <tr> <td>Terminal diameter 引线直径</td> <td>Force 张力</td> </tr> <tr> <td>≤0.8mm</td> <td>4.9N</td> </tr> <tr> <td>>0.8mm</td> <td>9.8N</td> </tr> </table>	Terminal diameter 引线直径	Force 张力	≤0.8mm	4.9N	>0.8mm	9.8N	无明显机械性损伤 No remarkable mechanical damage
Terminal diameter 引线直径	Force 张力							
≤0.8mm	4.9N							
>0.8mm	9.8N							
振动 Vibration	<p>将主体牢固安装在振动板上，在振动频率 10 Hz→55 Hz→10 Hz 范围内，将振幅为 0.75 mm (全振幅 1.5 mm)，往复时间约 1 分钟的单弦调和振动施加在垂直的 3 个方向，各进行 2 小时，过目测观察外观有无异常。</p> <p>After repeatedly applying a single harmonic vibration (amplitude: 0.75mm, double amplitude: 1.5 mm) with 1 minute vibration frequency cycles (10 Hz to 55 Hz to 10 Hz) to each of three perpendicular directions for 2 hours. Thereafter, the unit shall be visually examined.</p>	无明显机械性损伤 No remarkable mechanical damage						
可焊性 Solderability	<p>将导线浸入 235±5℃ 锡槽 2±0.5 秒，浸入深度离本体约 3mm。</p> <p>After dipping the terminals to a depth of approximately 3 mm from the body in a soldering bath of 235±5°C for 2±0.5 seconds, the terminal shall be visually examined.</p>	至少 95 % 的端子需通过全新焊锡进行覆盖 Approximately 95 % of the terminals shall be covered with new solder uniformly.						
耐焊接热 Resistance to Soldering Heat	<p>将端子浸渍在 260±5℃ 的焊锡槽中，至端子上方 2.0~2.5 mm，使用 t=1.5 mm 的遮挡板（印制基板），浸渍时间 10±1 秒，然后放置在室温下 1 至 2 小时。检查 V_{CMA} 的变化与机械损伤。</p> <p>After each lead shall be dipped into a solder bath having a temperature of 260±5 °C to a point 2.0 to 2.5 mm from the body of the unit, using shielding board (t=1.5 mm), be held there for 10±1 s and then be stored at room temperature and normal humidity for 1 to 2 hours. The change of V_{CMA} and mechanical damages shall be examined.</p>	$\Delta V_{CMA}/V_{CMA} < \pm 5 \%$ 无明显机械性损伤 No remarkable mechanical damage						

环境特性

Environmental characteristics

特性 Characteristics	试验方法 Test Methods	标准 Specifications
高温贮存 High Temperature Storage	<p>125±2℃ 温度下，无负荷条件下放置 1000 小时后，在放回至常温常湿环境中 1 至 2 小时后，测定其特性。</p> <p>The specimen shall be subjected to 125±2 °C for 1000 hours in a thermostatic bath without load and then stored at room temperature and normal humidity for 1 to 2 hours. Thereafter, the change of V_{CMA} shall be measured.</p>	$\Delta V_{CMA}/V_{CMA} < \pm 5 \%$
耐湿性 Humidity	<p>40±2℃ 温度下，湿度 90~95%RH 环境中，无负荷条件下放置 1000 小时后，在放回至常温常湿环境中 1 至 2 小时后，测定其特性。</p> <p>The specimen shall be subjected to 40±2 °C, 90 to 95 % RH for 1000 hours without load and then stored at room temperature and normal humidity for 1 to 2 hours. Thereafter, the change of V_{CMA} shall be measured.</p>	$\Delta V_{CMA}/V_{CMA} < \pm 5 \%$
低温贮存 Low Temperature Storage	<p>-40±2℃ 温度下，无负荷条件下放置 1000 小时后，在放回至常温常湿环境中 1 至 2 小时后，测定其特性。</p> <p>The specimen shall be subjected to -40±2 °C without load for 1000 hours and then stored at room temperature and normal humidity for 1 to 2 hours. Thereafter, the change of V_{CMA} shall be measured.</p>	$\Delta V_{CMA}/V_{CMA} < \pm 5 \%$
高温负荷 High Temperature Load	<p>85±2℃ 温度下，接通最大允许电压 1000 小时，放回至常温常湿环境中 1 至 2 小时后，测定其特性。</p> <p>After being continuously applied the Maximum Allowable Voltage at 85±2 °C for 1000 hours, the specimen shall be stored at room temperature and normal humidity for 1 to 2 hours. Thereafter, the change of V_{CMA} shall be measured.</p>	$\Delta V_{CMA}/V_{CMA} < \pm 10 \%$
耐湿负荷 Humidity Load	<p>40±2℃ 温度下，湿度 90~95%RH 环境中，接通最大允许电压 1000 小时，放回至常温常湿环境中 1 至 2 小时后，测定其特性。</p> <p>The specimen shall be subjected to 40±2 °C, 90 to 95 % RH and the Maximum Allowable Voltage for 1000 hours and then stored at room temperature and normal humidity for 1 to 2 hours. Thereafter, the change of V_{CMA} shall be measured.</p>	$\Delta V_{CMA}/V_{CMA} < \pm 10 \%$

特性 Characteristics	试验方法 Test Methods	标准 Specifications															
温度循环 Temperature Cycle	<p>进行如下循环5次，之后放置在常温常湿环境中1至2小时，目测外观有无异常，并测定其特性。 The temperature cycle shown below shall be repeated five cycles and then stored at room temperature and normal humidity for 1 to 2 hours. The change of V_{CMA} and mechanical damage shall be examined.</p> <table border="1" data-bbox="502 387 1082 607"> <thead> <tr> <th>步骤 Step</th> <th>温度 (°C) Temperature (°C)</th> <th>时间 (分钟) Period (minutes)</th> </tr> </thead> <tbody> <tr> <td>1</td> <td>-40±3</td> <td>30±3</td> </tr> <tr> <td>2</td> <td>常温 Room temp.</td> <td>15±3</td> </tr> <tr> <td>3</td> <td>+125±2</td> <td>30±3</td> </tr> <tr> <td>4</td> <td>常温 Room temp.</td> <td>15±3</td> </tr> </tbody> </table>	步骤 Step	温度 (°C) Temperature (°C)	时间 (分钟) Period (minutes)	1	-40±3	30±3	2	常温 Room temp.	15±3	3	+125±2	30±3	4	常温 Room temp.	15±3	$\Delta V_{CMA}/V_{CMA} < \pm 5\%$
步骤 Step	温度 (°C) Temperature (°C)	时间 (分钟) Period (minutes)															
1	-40±3	30±3															
2	常温 Room temp.	15±3															
3	+125±2	30±3															
4	常温 Room temp.	15±3															

■ 试验电流波形图

Testing current waveform

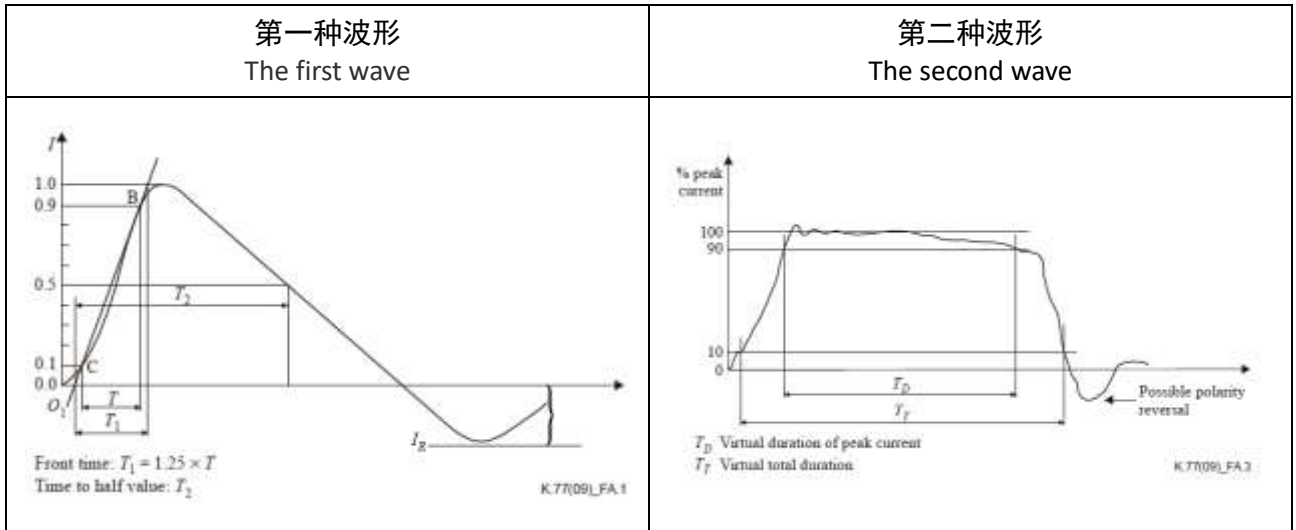

安全注意事项

Safety Precautions

使用WZV压敏电阻器（以下简称WZV或产品名称）时，WZV周围条件（设备设计中的材料、环境、电源条件、电路条件等）发生异常时，则可能引发火灾、触电、烧伤、以及产品故障。下列内容为使用时的相关注意事项，请认真确认后再行使用。如对未及事项有疑议，请速与我公司担当部门联系。

In case that a WZV varistor (hereafter referred to as the WZV, or product name) is used, if an abnormality takes place because of peripheral conditions of the WZV(material, environments, power source conditions, circuit conditions, etc. in equipment design), fire, electric shock, burn, or product failure may occur. The precautions for this product are described below, understand the content thoroughly before usage. For more questions, contact us.

1. 严格遵守事项

Precautions to be strictly observed

1.1 额定性能确认

Confirmation of performance ratings

请遵守WZV的最大允许电压，耐浪涌电流（最大峰值电流）、最大能量(能量耐量)，浪涌寿命，平均脉冲功率和操作温度范围等额定性能的规定，在规定范围内使用。超出规定范围使用，则会造成WZV性能劣化，破坏元件，严重可引起WZV冒烟或起火。

Use the WZV within its rated range of performance such as the maximum allowable voltage, maximum peak current (withstanding surge current), maximum energy (Withstanding energy), impulse life(surge life), average pulse power, and operating temperature range. If used outside the range, the WZV can be degraded and have element fracture, which may result in smoking and ignition.

1.2 为避免意外现象发生，请采用如下对策

To avoid accidents due to unexpected phenomena, take the following measures

1) WZV受损时，可能出现WZV破碎飞散，因此要对集成产品加保护盖或外盒。

In the event of fracture of the WZV, its pieces may scatter; hence, put the case or cover of the set product in place.

2) 请勿安装在可燃物品（塑料电线、树脂合成物等）附近。若无法避免，请使用不燃性保护外壳。

Do not install the WZV near combustibles (polyvinyl chloride wires, resin moldings, etc.). If it is difficult to do, install a nonflammable cover.

3) 线间使用

Across-the-line use

在线间使用时，将保险丝与WZV串联（参考2.1项之1)节(4)款与表1）。

When the WZV is used across a line, put a current fuse in series with the WZV. (Refer to Item 2.1.1). (4) and Table 1) .

4) 线-地间使用

Use between line to ground

(1) 在线-地间使用时，WZV短路时会产生接地电阻，电流保险丝不会熔断，可能引起WZV外涂层树脂冒烟或起火。为避免上述情况，请在电源端安装漏电断路器。如无漏电断路器，则需将电流保险丝与温度保险丝串联使用。（参照表1）

If the case that the WZV is used between a line to the ground, the short-circuit of the WZV may not blow the current fuse because of grounding resistance, which may cause smoking and ignition of the WZV's exterior resin. As the measure against it, install an earth leakage breaker on the power supply side of the WZV position. If no earth leakage breaker is installed, use a thermal fuse together with a current fuse in series. (Refer to Table 1.)

(2) 在带电部件与金属部件之间使用WZV时，WZV短路时有触电危险，故请将金属部件接地或勿与人体接触。

If the case that the WZV is used between a live part to metal case, an electric shock may develop at a shortcircuit of the WZV ; hence, ground the metal case to the ground or keep it from the human body.

2. 使用注意事项

Application notes

2.1 注意下列事项，可能导致WZV寿命缩短或引发故障

Pay attention to the following items to avoid the shortened life and failure of the WZV

1) 电路条件

Circuit conditions

- (1) 选定的WZV的电压最大值在最大容许电压值之上。（参照表1）

Select a WZV of which the maximum voltage including fluctuations in source voltage allows for the maximum permissible circuit voltage. (Refer to Table 1)

- (2) 短间隔性地施加浪涌时（施加抗干扰模拟试验电压时），不可超过WZV的最大平均脉冲功率。

In cases that surges are intermittently applied at short intervals (for example, in case that the voltage of the noise simulator test is implemented etc.), do not let them exceed the WZV's rated power.

- (3) 选定WZV时，须按照表1的标准产品型号

Select a WZV recommended in Table 1.

① 线间使用

Across-the-line use

单相三线式连线时单独配线负荷导致负荷不平衡、电压线和中性线短路、中性线欠损、容量性负荷情况下开闭时的共振等，将导致电源电压的上升，可能使用表1中标有*的产品型号。

If possible, use a Part No. marked with * in case of voltage temporarily rises load unbalance of separately-wired loads, short between hot and neutral-line, open of neutral line in single-phase-three-wired system, and due to resonance at switching for a capacitive, inductive load.

② 线-地间使用

Used between line to ground

出现故障时，对地电压将上升，因此，请使用另表1中推荐的产品型号。

Use a different Part No. from "Across-the-line use" as table 1, because of raising voltage in case of "Line to Ground Fault".

进行设备的绝缘电阻试验（DC 500 V）时，请使用表1中推荐的标有**的产品型号。使用不可清除绝缘性能试验的压敏电阻电压时，在一定的电路条件下，试验时可将压敏电阻器从电路上取下。

Use a Part No. marked with ** in table 1, in case of the insulation resistance test (500 VDC) for equipment. When using a Part of the varistor voltage that the insulation efficiency examination can not be cleared, there is a case where the varistor can be done by removing it from the circuit depending on the circuit condition.

进行设备的耐电压试验（AC 1000 V 或 AC 1200 V）时，请使用表1中推荐的标有***的产品型号。

Use a Part No. marked with *** in table 1, in case of the withstanding voltage test (1000 VAC or 1200 VAC) for equipment.

- (4) 关于电流保险丝

Concerning current fuse

- ① 所用WZV与电流保险丝的额定电流，一般推荐按下表进行选定。此外，在用户端，当WZV损坏时，确认其设备是否会发生2次伤害。

We recommend selecting a WZV and the rated current of a current fuse as follows.

Finally, please be sure that there is no danger if the WZV mounted on the equipment breaks.

规格 Specs	05D	07D	10D	14D	20D
保险丝额定电压 Fuse rated current	<2A	<3A	<5A	<7A	<10A

- ② 保险丝的插入部位建议按表1操作。但被保护设备的负荷电流较大、超过上述推荐保险丝额定电流时。电流保险丝请按下图连接。

The recommended fuse position is shown in table 1, "Example of WZV application", however, if the load current of protected equipment is larger than that of the above recommended fuse rated current, install a current fuse at the position shown below.

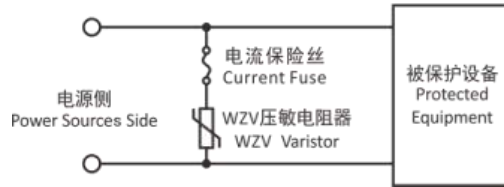

(5) 温度保险丝

Concerning thermal fuse

将WZV与温度保险丝连接时，用户端请尽量选用热结合较好的保险丝。

Set a thermal fuse to get high thermal conductivity with WZV.

表1 WZV的适用范例

Table 1 Example of WZV application

类别 Type		线间使用 Across-the-Line use	线-地使用 Use between Line to ground																																	
连线范例 DC / AC 单相	DC / AC 单相																																			
	AC 三相																																			
压敏电阻选型范例		<table border="1"> <thead> <tr> <th>WZV</th> <th>电源电压 Source voltage</th> <th>压敏电阻 varistor</th> </tr> </thead> <tbody> <tr> <td rowspan="6">WZV1 WZV3</td> <td>AC100V</td> <td>201 - 361*</td> </tr> <tr> <td>AC120V</td> <td>241 - 431*</td> </tr> <tr> <td>AC200V</td> <td>471 - 621*</td> </tr> <tr> <td>AC220V</td> <td>471 - 621*</td> </tr> <tr> <td>AC240V</td> <td>511 - 621*</td> </tr> <tr> <td>AC380V</td> <td>821</td> </tr> </tbody> </table>	WZV	电源电压 Source voltage	压敏电阻 varistor	WZV1 WZV3	AC100V	201 - 361*	AC120V	241 - 431*	AC200V	471 - 621*	AC220V	471 - 621*	AC240V	511 - 621*	AC380V	821	<table border="1"> <thead> <tr> <th>WZV</th> <th>电源电压 Source voltage</th> <th>压敏电阻 varistor</th> </tr> </thead> <tbody> <tr> <td rowspan="6">WZV2 WZV4</td> <td rowspan="3">AC100V AC220V</td> <td>471</td> </tr> <tr> <td>511</td> </tr> <tr> <td>621*</td> </tr> <tr> <td rowspan="3">AC230V AC240V</td> <td>821**</td> </tr> <tr> <td>182***</td> </tr> <tr> <td>182***</td> </tr> <tr> <td>AC380V</td> <td>112**</td> </tr> <tr> <td></td> <td></td> <td>182***</td> </tr> </tbody> </table>	WZV	电源电压 Source voltage	压敏电阻 varistor	WZV2 WZV4	AC100V AC220V	471	511	621*	AC230V AC240V	821**	182***	182***	AC380V	112**			182***
WZV	电源电压 Source voltage	压敏电阻 varistor																																		
WZV1 WZV3	AC100V	201 - 361*																																		
	AC120V	241 - 431*																																		
	AC200V	471 - 621*																																		
	AC220V	471 - 621*																																		
	AC240V	511 - 621*																																		
	AC380V	821																																		
WZV	电源电压 Source voltage	压敏电阻 varistor																																		
WZV2 WZV4	AC100V AC220V	471																																		
		511																																		
		621*																																		
	AC230V AC240V	821**																																		
		182***																																		
		182***																																		
AC380V	112**																																			
		182***																																		

2) 操作温度范围

Operating temperature range

请在规定的操作温度范围内 (-40°C~+85°C) 使用，如果实际工作温度超出其操作温度范围，请对WZV的进行降额使用。下图为其降额曲线图。

Please use it within the specified operating temperature range (-40 ° C to + 85 ° C). If the actual working temperature is outside its operating temperature range, use the derating of WZV. The figure below shows the derating curve.

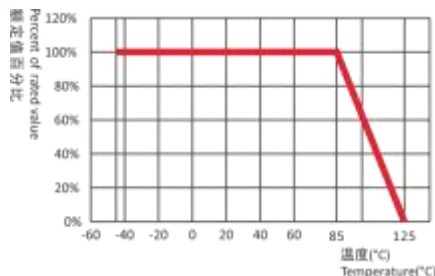

3) 使用环境

Operating environments

- (1) WZV不可在室外使用。

The WZV is designed to be used indoors. Do not use it exposed outdoors.

- (2) 不可在阳光直射场所、发热源附近或温度超过使用温度范围的场所使用。

Do not use the WZV in places exposed to temperatures beyond the operating temperature range, such as places exposed to sunlight and vicinities of heating equipment.

- (3) 不可在淋雨、蒸汽、高湿度的场所使用。

Do not use the WZV in places exposed to high temperatures and high humidity, such as places exposed directly to rain, wind, dew condensation, and vapor.

- (4) 不可在粉尘或盐分较多的场所以及被腐蚀性气体污染的环境中使用。

Do not use the WZV in dusty and salty places and atmospheres polluted by corrosive gases.

4) 加工条件

Processing conditions

- (1) 不可采用可能导致外涂层树脂劣化的溶剂（稀释剂、丙酮等）进行清洗。

Do not wash the WZV by such solvents (thinner, acetone, etc.) as its exterior resin deteriorates.

- (2) 不可施加可能导致外涂层树脂或元件出现破损的冲击或撞击、压力。

Do not apply a strong vibration or shock (by falling, etc.) to the WZV, cracking to its exterior resin and element may occur.

- (3) 将WZV进行树脂镀膜（含护膜塑模）时，不可使用可能导致WZV劣化的树脂。

When coating the WZV with resin (including molding), do not use such resin.

- (4) D型中，WZV外涂层树脂附近的引线部位不可进行强烈折弯或施加外力。

Do not bend the WZV type D lead wires at the position close to its WZV type D exterior resin, or apply external force to the position.

- (5) 焊接时，请在如下条件下进行。且不可将构成WZV的焊接部位或绝缘材料熔化。

When soldering the WZV lead wires, follow the recommended conditions and do not melt the solder and insulating materials constituting the WZV.

焊接方式 Soldering Method	推荐条件 Recommended Condition	注意 事 项 Attention Item
波峰焊 Flow soldering	260°C, 10 秒以内 260°C, within 10 sec.	D 型不是回流焊对象产品 Type D is not Reflow soldering object part.
上述以外的条件下使用时，请用户端自行确认。 For use other than the above conditions, please the client to confirm. 仅限进行1次返工，烙铁温度400 °C以下，时间控制在5秒以内。 Only 1 times rework, soldering iron temperature should not exceed 400 °C and should not be applied for mor than 5 seconds.		

■ 推荐焊接条件

Soldering temperature-time profile to recommend

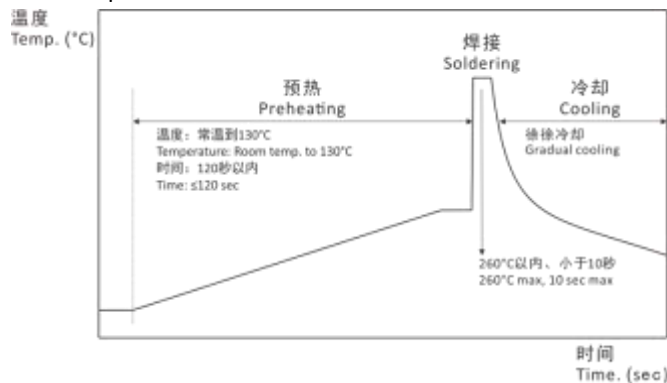

5) 长期保管

Long-term storage

- (1) WZV不可保存在高温、高湿场所。保存场所室温40 °C以下，湿度75 %RH以下，使用期限为2年。

Do not store the WZV under high temperature and high humidity. Store it at a temperature up to 40 °C and at

humidity below 75 %RH, and use it within two years.

长期间保管（2年以上）时，使用时请确认产品的可焊性。

Before using the WZV that has been stored for a long period (two years or longer), confirm the solderability.

- (2) 不可保存在腐蚀性气体（硫化氢、亚硫酸、氯气、氨气等）环境中。

Avoid atmospheres full of corrosive gases (hydrogen sulfide, sulfurous acid, chlorine, ammonia, etc.).

- (3) 保存场所避免阳光直射、结露等。

Avoid direct sunlight and dew condensation.

3. 说明

Notices

- 3.1 用于可靠性要求极高的设备（航空航天设备、医疗设备等）时，请事先至本公司咨询使用型号和保护措施等相关事宜。

In cases that the WZV is used in equipment (aerospace equipment, medical equipment, etc.) requiring extremely high reliability, ask us for a selection of Part No., and protection coordination, etc. in advance.

- 3.2 若未按照产品规格说明书记载事项进行操作，并由此导致出现异常时，本公司不负任何责任。

Note that we do not take any responsibility for faults and abnormalities resulting from the use not in conformity with the contents of entries in the delivery specification.

- 3.3 出现使用电路电压的异常上升、超大电涌的侵入等不可预期因素时，可能导致WZV起火。为防止延烧到使用设备上，外部结构材料需使用阻燃材料进行多重保护。

There is a possibility that the WZV will unexpectedly cause smoke or ignite because of an abnormal rise of the circuit voltage and invasion of excessive surge. To prevent that accident from spreading over the equipment and not to expand the damage, use multiplex protection such as the adoption of flame-retardant materials for housing parts and structural parts.

20D 系列

20D series

■ 电压电流特性曲线
Voltage vs. Current

20D820K – 20D511K

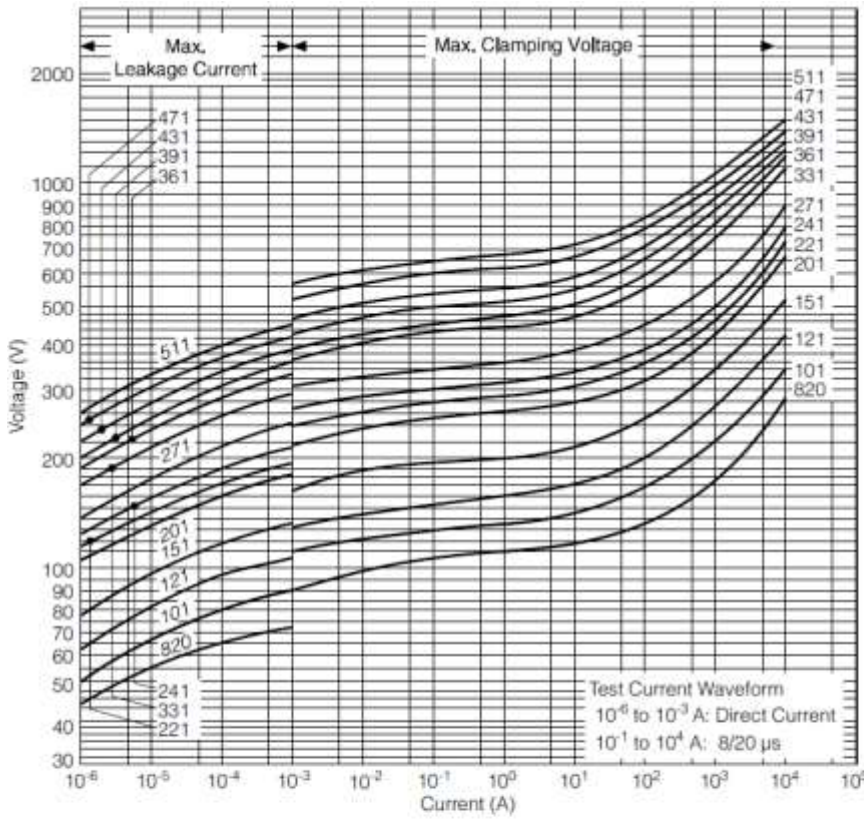

■ 脉冲降额曲线
Impulse Derating

20D820K – 20D511K

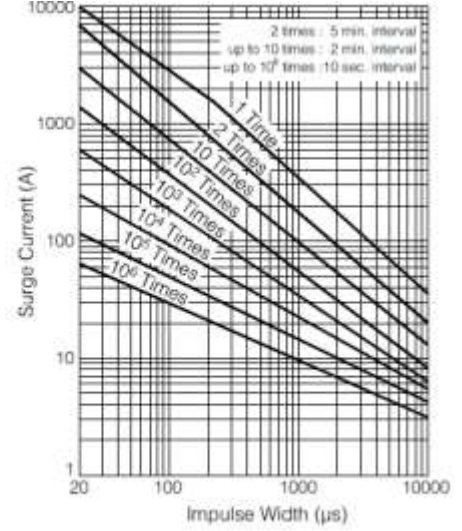

20D511K – 20D112K

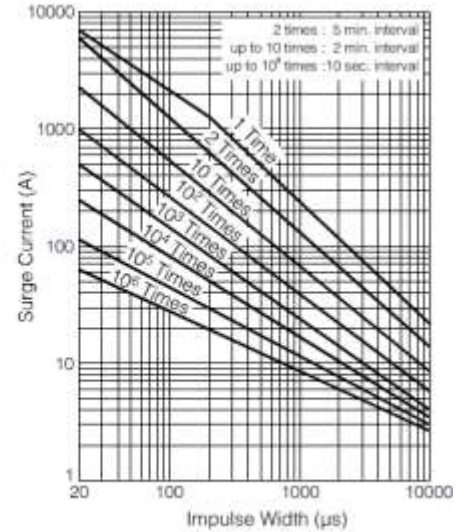

20D511K – 20D182K

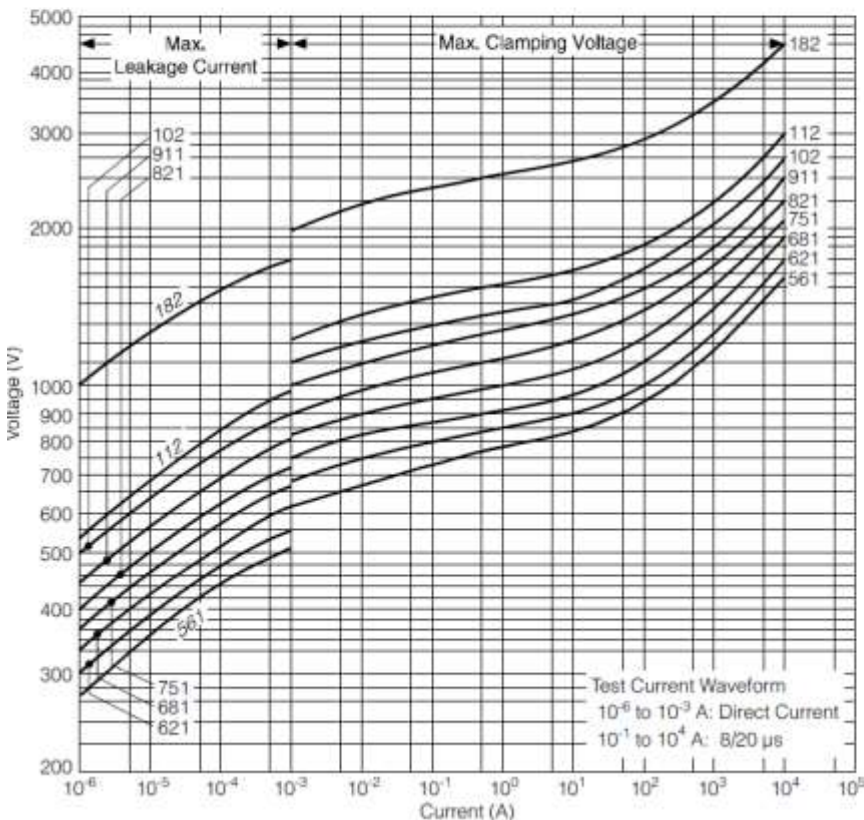

20D182K

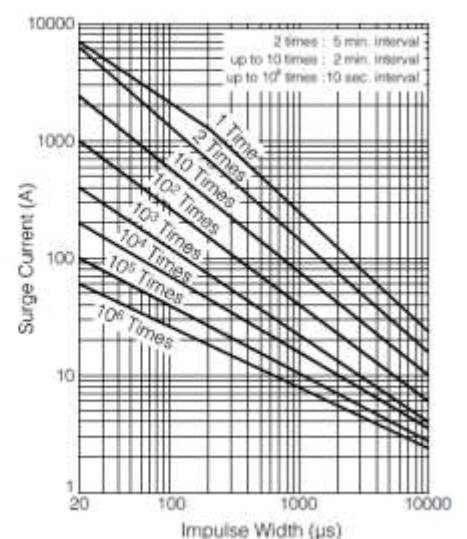

■ 电压电流特性曲线
Voltage vs. Current

20D180K – 20D680K

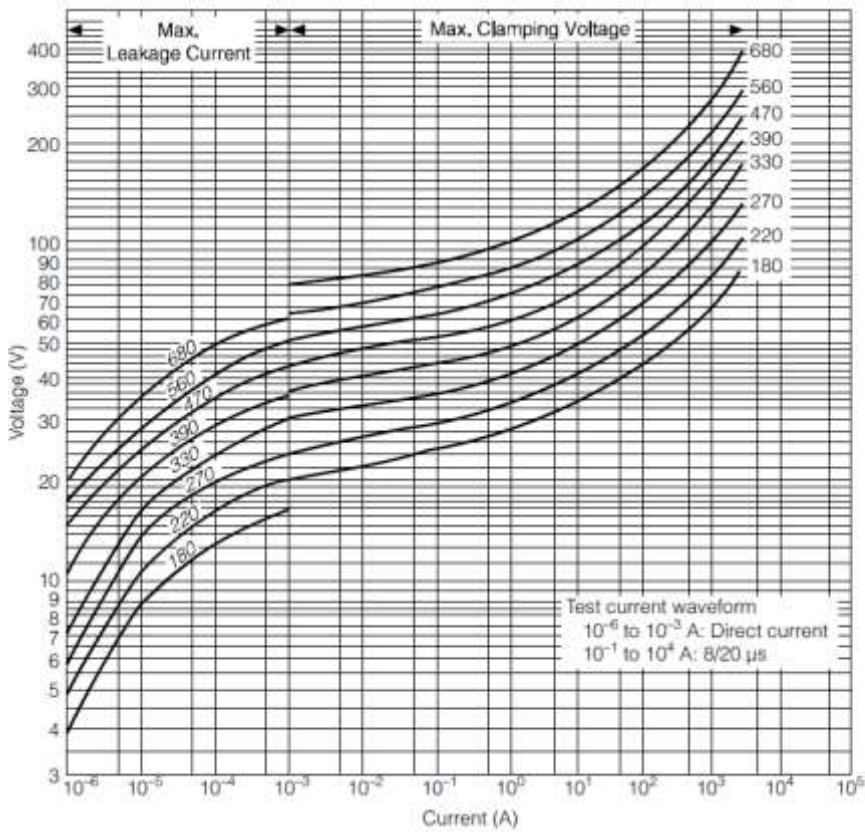

■ 脉冲降额曲线
Impulse Derating

20D180K – 20D680K

